



5MM SCREWLESS SLIM DESIGN DECORATIVE METAL PLATE & METAL ROCKERS

Safety - Suitable only for indoor installations. Before starting any electrical work always switch off at the mains. If in any doubt consult a qualified electrician. Ensure that the earth is connected otherwise it will be unsafe. Wire / Wiring colours in accordance with IEE Wiring Regulations.

Important - Please ensure to use the gasket supplied when installing this product. The gasket fits between the product & the wall & it prevents the possibility of discolouration of the metal face plate due to moisture in your wall after fresh wallpaper / plastering.

Maintenance - To help maintain the original finish of this product, wipe a soft cloth over the face plate periodically.

GENERAL WIRING INSTRUCTIONS

- 1) Switch off at the mains in order to isolate the area in which you intend to install your product
- 2) Ensure that there is sufficient length of mains cable / telephone cable / television cable to enable easy wiring, and not too much to make losing the excess length in the back of the product too difficult
- 3) Tighten the screw terminals onto the exposed wires (do not over-tighten) maintaining correct polarity using the easy to follow wiring diagrams for each individual product (identified by product model number).

POLARITY CONNECTIONS

BROWN (RED) TO L – LIVE
 BLUE (BLACK) TO N – NEUTRAL
 BLUE (BLACK) TO N – NEUTRAL
 GREEN / YELLOW (BARE EA RTH WIRES) TO E – EA RTH

Model Nos:

5MPLUS-101 etc.

10 amp Plate Switches:

1 Way Switching

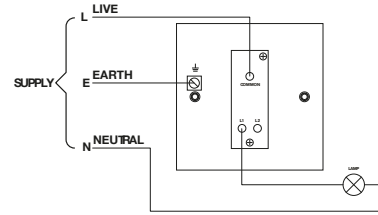

POLARITY CONNECTIONS

BROWN (RED) TO L – LIVE
 BLUE (BLACK) TO N – NEUTRAL
 GREEN / YELLOW (BARE EA RTH WIRES) TO E – EA RTH

Model Nos:

5MPLUS-102 etc.

10 amp Plate Switches:

2 Way Switching

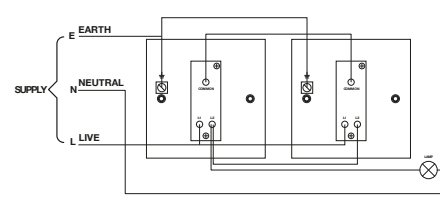

POLARITY CONNECTIONS

BROWN (RED) TO L – LIVE
 BLUE (BLACK) TO N – NEUTRAL
 GREEN / YELLOW (BARE EA RTH WIRES) TO E – EA RTH

Model Nos:

5MPLUS-103 etc.

10 amp Plate Switches:

3 Way Switching (2 x 10A Switches + 1 Intermediate Switch)

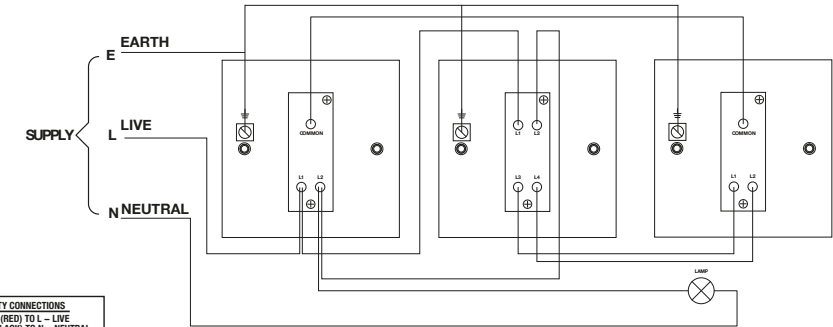

POLARITY CONNECTIONS

BROWN (RED) TO L – LIVE
 BLUE (BLACK) TO N – NEUTRAL
 GREEN / YELLOW (BARE EA RTH WIRES) TO E – EA RTH

Disclaimer

This equipment is intended for domestic use. It must be installed in accordance with the wiring installation instructions given. It must be fitted in the conventional way to a solid or stud partition wall. Wallpaper / wallpaper paste of any sort should not continue beneath the plate towards the working parts of the equipment.

The equipment should not be used in areas of high humidity (eg: bathrooms, swimming areas etc) nor within reach of a water source.

The equipment should be fitted to a mains supply of the appropriate voltage (indicated on the product). Care should be taken not to overload the equipment. No liability can be accepted if the product is installed contrary to any of the terms / instructions given.

If in any doubt whatsoever, you must consult a qualified electrician.

Model Nos:

5MPLUS-135 etc.

Satellite Socket, 1 Gang

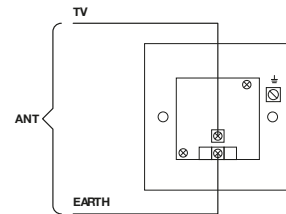

POLARITY CONNECTIONS

BROWN (RED) TO L – LIVE
 BLUE (BLACK) TO N – NEUTRAL
 GREEN / YELLOW (BARE EA RTH WIRES) TO E – EA RTH

Model Nos:

5MPLUS-136 etc.

TV/Satellite Socket, 1 x TV or FM, 1 x Satellite

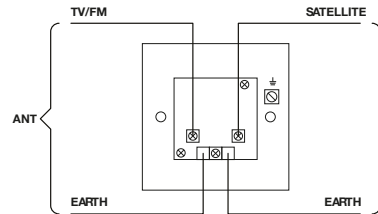

POLARITY CONNECTIONS

BROWN (RED) TO L – LIVE
 BLUE (BLACK) TO N – NEUTRAL
 GREEN / YELLOW (BARE EA RTH WIRES) TO E – EA RTH

Model Nos:

5MPLUS-137 etc.

TV/FM and Satellite Socket, 1 x Satellite, 2 x TV or FM

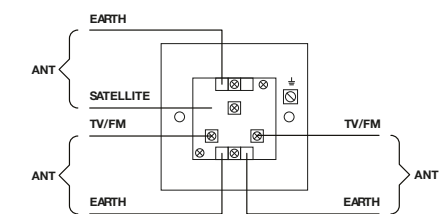

POLARITY CONNECTIONS

BROWN (RED) TO L – LIVE
 BLUE (BLACK) TO N – NEUTRAL
 GREEN / YELLOW (BARE EA RTH WIRES) TO E – EA RTH



Guarantee

This product is guaranteed against faulty workmanship or materials for a period of 5 years and will be refunded / repaired free of charge as long as it is returned to the vendor under the following conditions:

- 1) The product has not been overloaded or connected to a supply other than 230 / 240 volts 50z.
- 2) The installation procedure has been carried out correctly.
- 3) The product has not been tampered with (i.e: taken apart / repaired).

Under no circumstances can the Company accept responsibility for any damage said to arise from the use of this product.

LGA Europe Ltd, Cow Lane, Oldfield Road, Salford M5 4NB
www.selectricuk.co.uk

Screwless Faceplate Removal

- Place the product face down onto a soft surface.

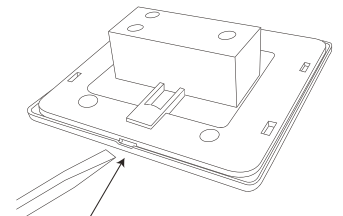

- Remove the decorative front plate by gently inserting the tip of a screwdriver in the slot on the side of the product and levering the plate away.

Model Nos:

5MPLUS-145 etc.

Satellite Socket, 2 Gang

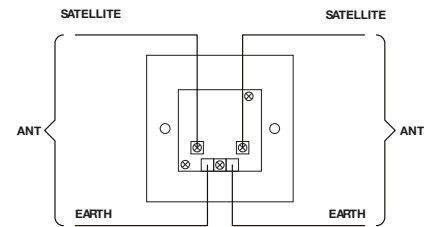

POLARITY CONNECTIONS

BROWN (RED) TO L – LIVE
 BLUE (BLACK) TO N – NEUTRAL
 GREEN / YELLOW (BARE EA RTH WIRES) TO E – EA RTH

Model Nos:

5MPLUS-138 etc.

Telephone Socket, 1 Gang Master Flush

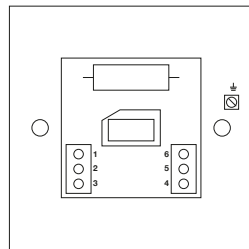

Pin	Colour
1	Green / White
2	Blue / White
3	Orange / White
4	White / Orange
5	White / Blue
6	White / Green

Model Nos:

5MPLUS-139 etc.

Telephone Socket, 1 Gang Secondary Flush

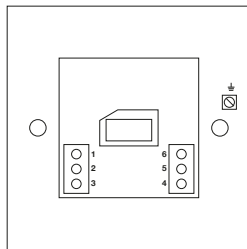

Pin	Colour
1	Green / White
2	Blue / White
3	Orange / White
4	White / Orange
5	White / Blue
6	White / Green

Model Nos:

5MPLUS-140 etc.

Computer/Data Socket, 1 Gang RJ45 Flush

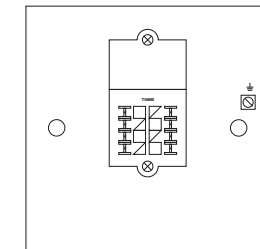

Pin	Colour
1	White Orange
2	Green / Orange
3	White Green
4	Blue
5	White Blue
6	Green
7	White Brown
8	Brown

Model Nos:

5MPLUS-141 etc.

Computer/Data Socket, 2 Gang RJ45 Flush

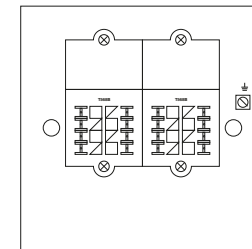

Pin	Colour
1	White Orange
2	Orange
3	White Green
4	Blue
5	White Blue
6	Green
7	White Brown
8	Brown

Model Nos:

5MPLUS-146 etc.

Cable Outlet / Connector, 20 amp with centre and side entry cable outlet

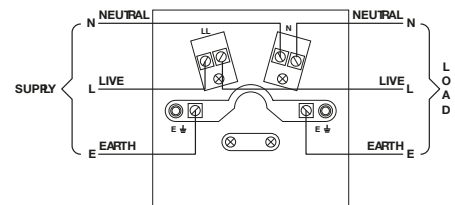

POLARITY CONNECTIONS

BROWN (RED) TO L – LIVE
 BLUE (BLACK) TO N – NEUTRAL
 GREEN / YELLOW (BARE EA RTH WIRES) TO E – EA RTH

Model Nos:
5MPLUS-108 etc.

10 amp Plate Switch, 3 Pole Fan Isolator

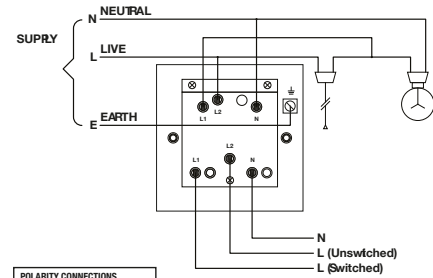

POLARITY CONNECTIONS
BROWN (RED) TO L - LIVE
BLUE (BLACK) TO N - NEUTRAL
GREEN / YELLOW (BARE EARTH WIRES) TO E - EARTH

Model Nos:
5MPLUS-115 etc.

20 amp DP Switch

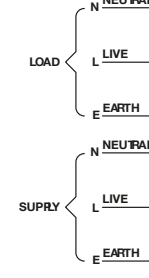

POLARITY CONNECTIONS
BROWN (RED) TO L - LIVE
BLUE (BLACK) TO N - NEUTRAL
GREEN / YELLOW (BARE EARTH WIRES) TO E - EARTH

Model Nos:
5MPLUS-116 etc.

20 amp DP Switch with Neon

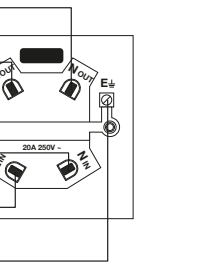

POLARITY CONNECTIONS
BROWN (RED) TO L - LIVE
BLUE (BLACK) TO N - NEUTRAL
GREEN / YELLOW (BARE EARTH WIRES) TO E - EARTH

Model Nos:
5MPLUS-147 etc.,

45 amp DP Switch, 1 Gang Plate

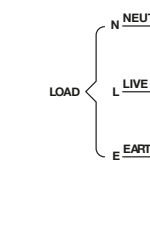

POLARITY CONNECTIONS
BROWN (RED) TO L - LIVE
BLUE (BLACK) TO N - NEUTRAL
GREEN / YELLOW (BARE EARTH WIRES) TO E - EARTH

Model Nos:
5MPLUS-117 etc.

45 amp DP Switch with Neon, 1 Gang Plate

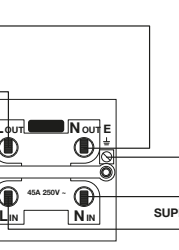

POLARITY CONNECTIONS
BROWN (RED) TO L - LIVE
BLUE (BLACK) TO N - NEUTRAL
GREEN / YELLOW (BARE EARTH WIRES) TO E - EARTH

Model Nos:
5MPLUS-148 etc.,

45 amp DP Switch 2 Gang Plate

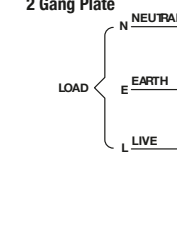

POLARITY CONNECTIONS
BROWN (RED) TO L - LIVE
BLUE (BLACK) TO N - NEUTRAL
GREEN / YELLOW (BARE EARTH WIRES) TO E - EARTH

Model Nos:
5MPLUS-118 etc.

45 amp DP Switch with Neon, 2 Gang Plate

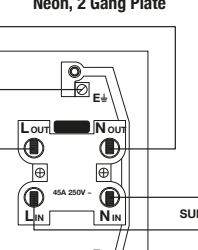

POLARITY CONNECTIONS
BROWN (RED) TO L - LIVE
BLUE (BLACK) TO N - NEUTRAL
GREEN / YELLOW (BARE EARTH WIRES) TO E - EARTH

Model Nos:
5MPLUS-119 etc.

13 amp Socket Outlet, 1 Gang Unswitched

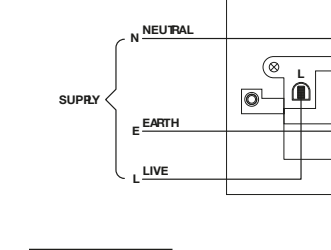

POLARITY CONNECTIONS
BROWN (RED) TO L - LIVE
BLUE (BLACK) TO N - NEUTRAL
GREEN / YELLOW (BARE EARTH WIRES) TO E - EARTH

Model Nos:
5MPLUS-151 etc.

13 amp Socket Outlet, 2 Gang Switched

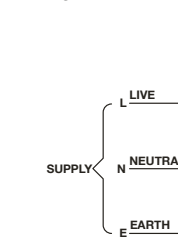

POLARITY CONNECTIONS
BROWN (RED) TO L - LIVE
BLUE (BLACK) TO N - NEUTRAL
GREEN / YELLOW (BARE EARTH WIRES) TO E - EARTH

Model Nos:
5MPLUS-121 etc.,

13 amp Socket Outlet, 1 Gang DP

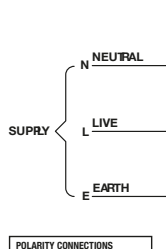

POLARITY CONNECTIONS
BROWN (RED) TO L - LIVE
BLUE (BLACK) TO N - NEUTRAL
GREEN / YELLOW (BARE EARTH WIRES) TO E - EARTH

Model Nos:
5MPLUS-123 etc.,

13 amp Socket Outlet, 1 Gang DP with Neon

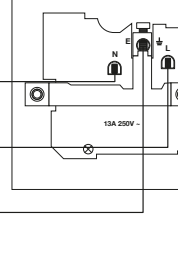

POLARITY CONNECTIONS
BROWN (RED) TO L - LIVE
BLUE (BLACK) TO N - NEUTRAL
GREEN / YELLOW (BARE EARTH WIRES) TO E - EARTH

Model Nos:
5MPLUS-122, 5MPLUS-322,

13 amp Socket Outlet, 2 Gang Switched DP

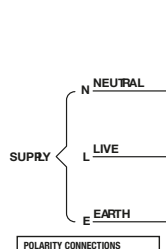

POLARITY CONNECTIONS
BROWN (RED) TO L - LIVE
BLUE (BLACK) TO N - NEUTRAL
GREEN / YELLOW (BARE EARTH WIRES) TO E - EARTH

Model Nos:
5MPLUS-124 etc.,

13 amp Socket Outlet, 2 Gang Switched DP with Neon

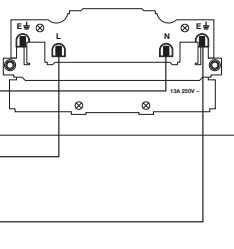

POLARITY CONNECTIONS
BROWN (RED) TO L - LIVE
BLUE (BLACK) TO N - NEUTRAL
GREEN / YELLOW (BARE EARTH WIRES) TO E - EARTH

Model Nos:
5MPLUS-160 etc.

13 amp USB Socket Outlet, 1 Gang Switched DP

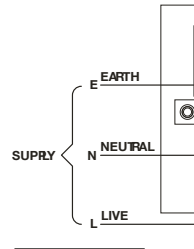

POLARITY CONNECTIONS
BROWN (RED) TO L - LIVE
BLUE (BLACK) TO N - NEUTRAL
GREEN / YELLOW (BARE EARTH WIRES) TO E - EARTH

Model Nos:
5MPLUS-161 etc.

13 amp USB Socket Outlet, 2 Gang Switched DP

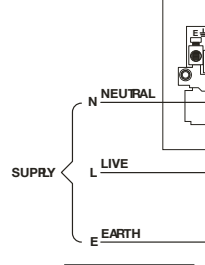

POLARITY CONNECTIONS
BROWN (RED) TO L - LIVE
BLUE (BLACK) TO N - NEUTRAL
GREEN / YELLOW (BARE EARTH WIRES) TO E - EARTH

Model Nos:
5MPLUS-125 etc.

Round Pin Socket Outlet, 2 amp 3 pin

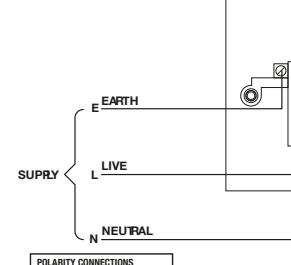

POLARITY CONNECTIONS
BROWN (RED) TO L - LIVE
BLUE (BLACK) TO N - NEUTRAL
GREEN / YELLOW (BARE EARTH WIRES) TO E - EARTH

Model Nos:
5MPLUS-126 etc.

Round Pin Socket Outlet, 5 amp 3 pin

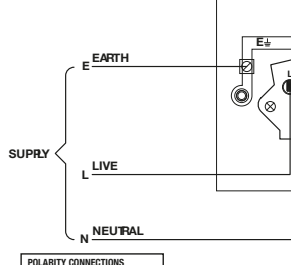

POLARITY CONNECTIONS
BROWN (RED) TO L - LIVE
BLUE (BLACK) TO N - NEUTRAL
GREEN / YELLOW (BARE EARTH WIRES) TO E - EARTH

Model Nos:
5MPLUS-127 etc.

Fused Connection Unit, 13 amp Unswitched

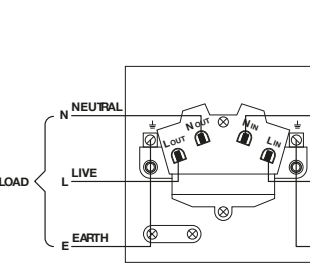

POLARITY CONNECTIONS
BROWN (RED) TO L - LIVE
BLUE (BLACK) TO N - NEUTRAL
GREEN / YELLOW (BARE EARTH WIRES) TO E - EARTH

Model Nos:
5MPLUS-128 etc.

Fused Connection Unit, 13 amp Switched

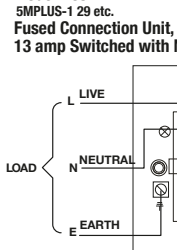

POLARITY CONNECTIONS
BROWN (RED) TO L - LIVE
BLUE (BLACK) TO N - NEUTRAL
GREEN / YELLOW (BARE EARTH WIRES) TO E - EARTH

Model Nos:
5MPLUS-130 etc.

Fused Connection Unit, 13 amp Switched with Neon and Flex Outlet

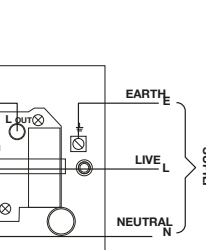

POLARITY CONNECTIONS
BROWN (RED) TO L - LIVE
BLUE (BLACK) TO N - NEUTRAL
GREEN / YELLOW (BARE EARTH WIRES) TO E - EARTH

Model Nos:
5MPLUS-149 etc.

45 amp Cooker Unit, 13 amp Switched Socket DP

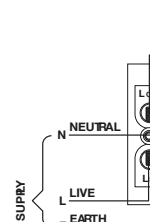

POLARITY CONNECTIONS
BROWN (RED) TO L - LIVE
BLUE (BLACK) TO N - NEUTRAL
GREEN / YELLOW (BARE EARTH WIRES) TO E - EARTH

Model Nos:
5MPLUS-131 etc.

45 amp Cooker Unit, 13 amp Switched Socket DP with Neons

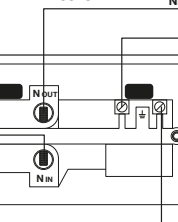

POLARITY CONNECTIONS
BROWN (RED) TO L - LIVE
BLUE (BLACK) TO N - NEUTRAL
GREEN / YELLOW (BARE EARTH WIRES) TO E - EARTH

Model Nos:
5MPLUS-132 etc.

Shaver Supply Unit, Dual Voltage 220/240v 50Hz Input 230/115v Output

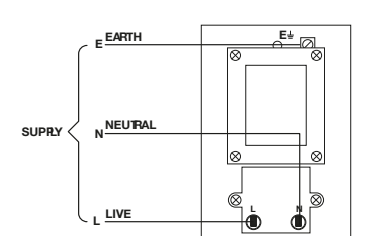

POLARITY CONNECTIONS
BROWN (RED) TO L - LIVE
BLUE (BLACK) TO N - NEUTRAL
GREEN / YELLOW (BARE EARTH WIRES) TO E - EARTH

Model Nos:
5MPLUS-133 etc.

TV Socket, 1 Gang

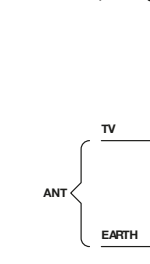

POLARITY CONNECTIONS
BROWN (RED) TO L - LIVE
BLUE (BLACK) TO N - NEUTRAL
GREEN / YELLOW (BARE EARTH WIRES) TO E - EARTH

Model Nos:
5MPLUS-134 etc.

TV Socket, 2 Gang

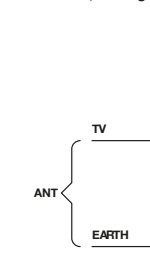

POLARITY CONNECTIONS
BROWN (RED) TO L - LIVE
BLUE (BLACK) TO N - NEUTRAL
GREEN / YELLOW (BARE EARTH WIRES) TO E - EARTH